



BADGE COURSE MANUAL

BOATSWAIN INTEREST BADGE



<i>Name</i>	
<i>Troop</i>	
<i>Course Date</i>	

CONTENTS

Section	Page
Boatswain - Badge Requirements	3
Rope work – Bends, Hitches & Knots	4
Splicing – Back & Eye	6
Whipping – Sailmakers & West Country	7
Fenders	7
How to make a lanyard	8
Boatswain's Chair	13
Purchase tackles	13
Sail maintenance	14
Stitching	15
The Bosun's Call and Pipes	16
Contents of a Boat Bag	18

Boatswain – Badge Requirements

1. Repair a small hole in a pulling boat OR patch a canvas or rubber hull OR repair a small hole in a fibre-glass hull.
2. Make the following bends, hitches or splices:
 - a) Back Splice, Eye Splice
 - b) Marline spike hitch
 - c) Double Carrick Bend
 - d) Catspaw
 - e) Mouse a hook
 - f) Turk's head
 - g) Hunter's bend in synthetic rope
 - h) Jury masthead knot
 - i) Boatswain's lanyard incorporating at least six sennits (ie boatswain's weave, rolling boatswain, half hitches, diamond knot, grapevine, three corner crownings, flat sennit, turk's head)
3. Make a Sailmaker's Whipping and make off correctly the ends of a nylon or plastic rope using heat.
4. Make a fender suitable for a pulling boat.
5. Demonstrate how to take care of, clean and remove stains from sails.
6. Identify 3 different synthetic fibres both in cloth and ropes.
7. Take part in painting and varnishing a boat.
8. Make the following pipes on a Bosun's Call:
 - a) The Still
 - b) Carry on
 - c) Pipe the Side
9. Make and use a Bosun's chair.
10. Overhaul and repair a set of standing rigging, in both wire and cordage, for an open sailing craft.
11. Demonstrate the uses of purchase tackles, and rig a purchase tackle.
12. Make a boat bag, using canvas, PVC or synthetic cloth. List the contents of the boat bag

Ropework

Timber Hitch:

This, as the name implies, is used for attaching a rope to a log or spar.

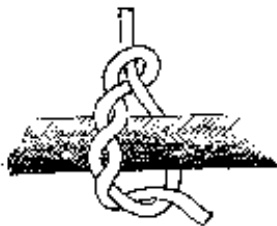

Marlin Spike Hitch:

This is generally only used as a temporary measure when a spike or piece of wood is to be attached to a rope as to provide a convenient grip or lever.



Blackwall Hitch:

Makes a simple way of attaching a rope to a hook.



Midshipman's Hitch:

This is a development of the Blackwall Hitch, but will hold better if the rope is greasy.



Bowline-on-a-bight:

Is used to form a double loop on a bight of a rope. The sizes of the two loops may be adjusted before the knot is tightened, but after tightening, they will be locked.

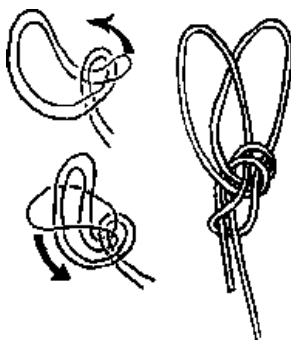

Running Bowline:

Is a common bowline with its loop enclosing the standing part, so as to form a running noose. Used for any purpose for which a slip knot is required.



Hunter's Bend:

The Hunter's Bend is a knot used to join two lines. It consists of interlocking overhand knots and can jam under moderate strain. Used in rigging and mooring.

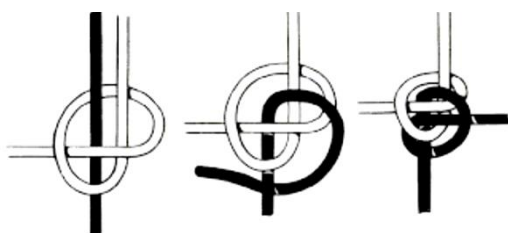

Double Carrick Bend:

This bend is used to join two thick lines together. It is very secure and simple to make and quick to release.

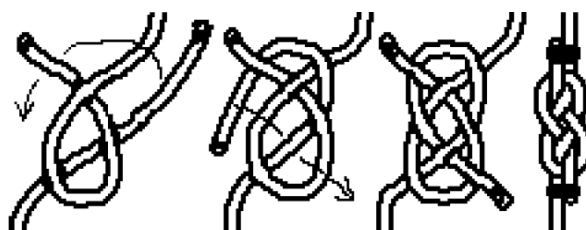

Catspaw:

Is used for making a temporary loop to attach a hook. The load may come on one or both parts of the rope, but if only on one part, then it is advisable to seize the parts together below the Catspaw.



Mousing a Hook:

Is simply a means of closing a hook, so that a ring or rope passing through it cannot come adrift.



Single Wall and Crown:

Is the basis of several fancy knots and is made in the strands of a rope by first forming a Wall Knot, then making a Crown Knot on top of it.

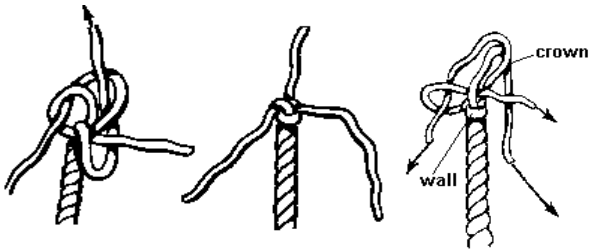

Matthew Walker:

Is a stopper or ornamental knot formed in the strands of a rope. The simplest way of making this knot, is to make a Wall Knot in the same direction as the lay of the rope, then take each end in turn up through the next loop. Pull tight evenly, then lay up the end strands, whip and cut off.



Turks Head:

There are many variations, but basically it is as follows:

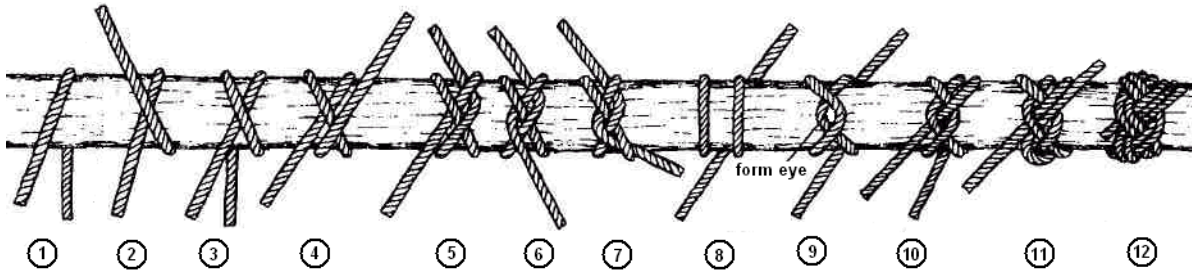

Jury Masthead Knot:

The Jury Knot is useful when a jury mast has to be rigged, as the loops form a means of attaching the necessary supports to the mast. The centre **K** is slipped over the masthead, and the weight brought on the stays tightens it and holds it in position on the mast. It is formed by three half hitches. Two of these are made and laid one behind the other **A** and **B**. A third hitch, **C**, is then made and slipped behind hitch **B** and over hitch **A**. This completes the first stage. Now, take **C** and draw it out under **B** and over **A**, and take **D** and draw it over **E** and under **F**, and draw out **G**. The ends **H** and **Z** may be either knotted or spliced.

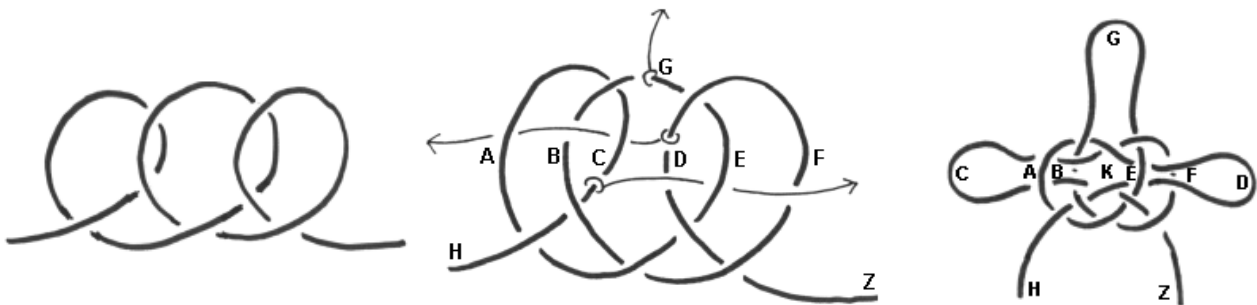

Splicing

Back Splice:

The back splice at the end of a three stranded rope makes a neat and permanent finish. But it also thickens the end, thus creating a problem with block and tackle, which may be to an advantage acting as a stopper. Commence the splice by making a crown knot, then continuing over and under for at least three tucks with each strand.

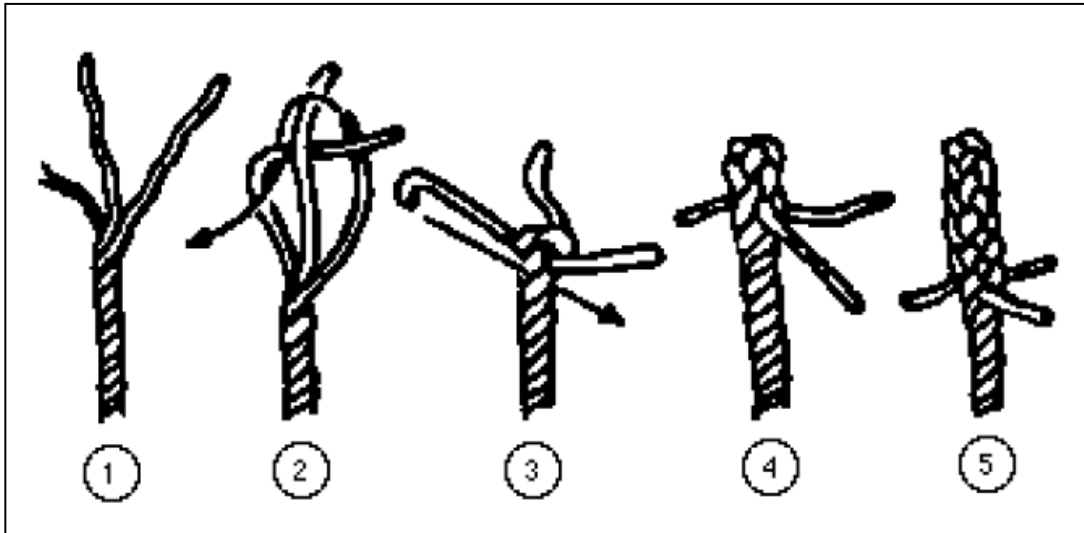

Eye Splice:

The eye splice is used to make a permanent loop or eye in the end of a three-stranded rope. Often a metal thimble is worked into the eye and then bound with twine. Carefully follow the illustrations, pulling each tuck up tight.

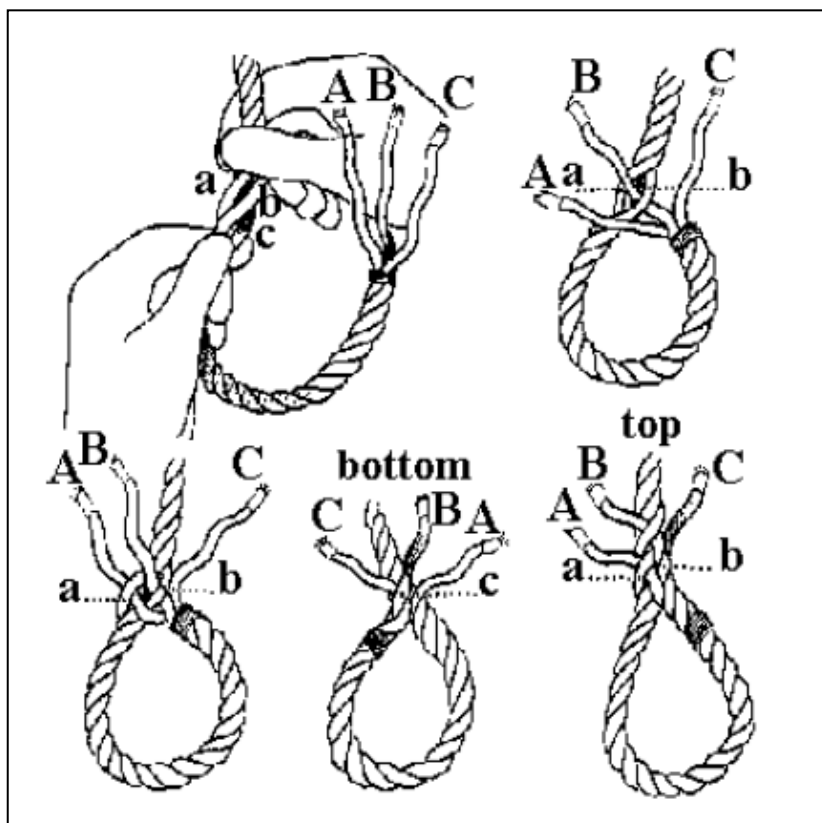

Whipping

Sailmaker's Whipping:

Sailmaker's Whipping is stronger than most others as the whipping line goes straight through the rope. On three-stranded rope, unlay the end for a few centimetres and lay a bight of whipping line through the rope, so that it encloses one strand and two ends, one long and one short, project from the opposite spaces. Do not pull the bight tight. Lay the strands again. Using the long end, bind round the rope from the bight towards the end of the rope for the distance equal to about two thirds the diameter of the rope. Raise bight up and over the end strand it already embraces and pull tight with the short end. Take the short end of the line up over the whipping, following the same space it protrudes from and tie the two ends together with a reef knot in the centre of the rope end.

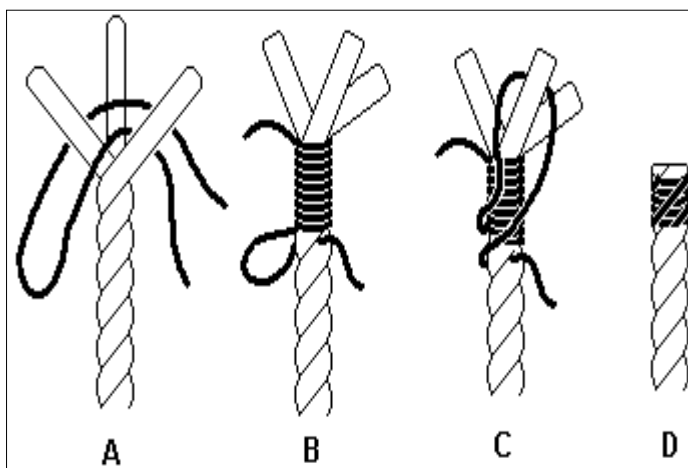

West Country Whipping:

The West Country Whipping is a secure whipping, because it holds onto the tightness gained with each turn as it is made. This is done by making a series of overhand knots on alternate sides of the rope being seized. Finish off with a reef knot.

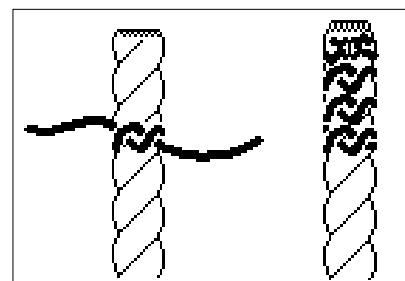

Synthetic Rope:

There are two methods of preventing a synthetic rope from fraying. First – heat the end of the rope with a flame. Once the rope melts, wet your fingers and shape the end into a point. Secondly, you can heat a knife until red hot and just cut the rope.

Fenders

Simple rope fenders can be made by putting a seizing on a bight of rope (2m long) to form the eye and another at the length the fender is to be (20cm). Then unlay the strands and lay up towards the eye in a series of Crown Knots or Wall Knots, or alternatively in the same or opposite direction. When the eye is reached, seize the strands below it and cut off the surplus.

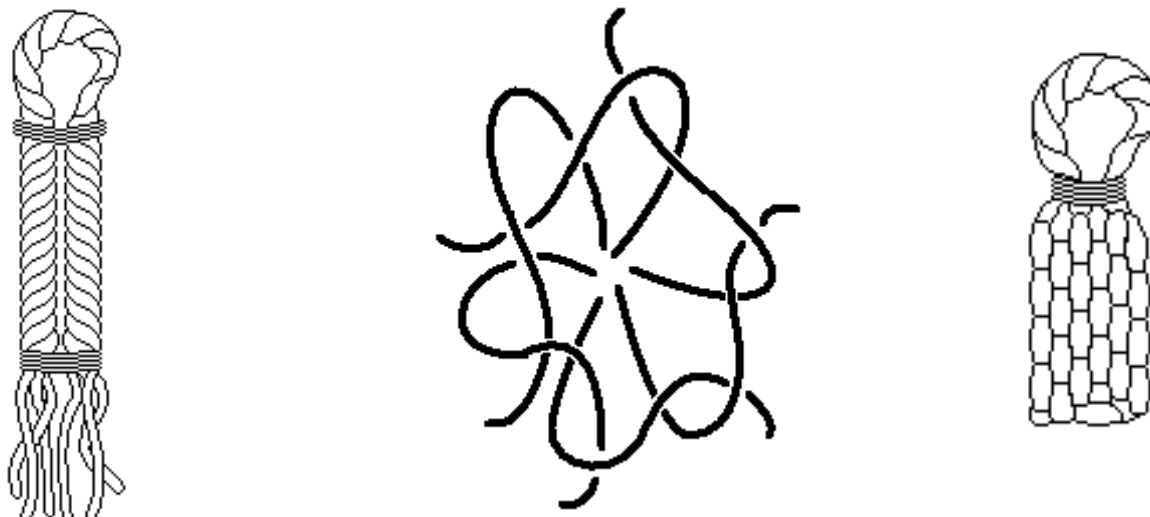

How to make a lanyard

A lanyard, of which a Sea Scout can be truly proud, should display not less than eight different knots and plaits, but these attractive lanyards need not be confined to Sea Scouts. Rovers and Scouts may like to make them also.

It is advisable to practice each knot and plait in ordinary string, before attempting the real thing. The lanyard maker's motto should be: "***pull tight***". A loosely woven lanyard is usually uneven in width, and looks untidy. Never continue working after a mistake has been made – always undo it and put it right. Lanyards last for years, and mistakes always seem to show up more when the lanyard is complete, causing continual annoyance to the maker!

A well-made lanyard should taper from the centre front where it joins, which will be its widest part, to the loop at the end, where it should be the thinnest. A lanyard takes two hanks (40m) of "plaiter's line".

Begin by dividing each hank in half and cutting the ends. This will result in you having four lengths of line, each ten metres long. Knot all four lengths loosely at about one third of their lengths and wind the four long ends onto bobbins made of cardboard, wood or something similar. And now, wind the four short ends on another four bobbins. The work has begun with the part which goes round the neck, which should measure about 1 metre. The part from the join to the loop at the end measuring a further 600 – 700 mm. A Scout should make the lanyard so that they can open their knife with one hand at arm's length.

Begin with the following plait; start close up to the knot, and working with the four long ends.

Portuguese Sennit (Boatswains Plait):

This is usually done with four strands, but the centre could be replaced by a strip of any other material or rope. It is made by tying overhand knots with the outer strands around the centre strand. If each knot is made the same way, the result will be a twisted Sennit. If made alternately in opposite directions, the result will be flat.

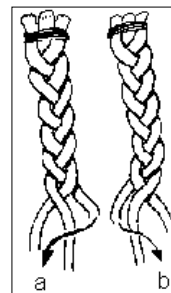

Flat Plait (English Sennit):

The Flat Plait done with three strands is very simple. With a larger number of strands, arrange the strands side by side, then take every second strand over the one on its left. Then take each one that has been crossed, over the next one on its right, and so on.

Boatswains Weave:

The two centre strands are used as a core and must lie flat, never crossing one another. They should be tied at the further end to a chair or piece of furniture and the near ends tucked into the workers belt, so as to hold the core taught and straight. Call the outside left end **A** and the outside right end **B**.

Lay **A** across the core, from left to right and pass it under **B**. Next, pass **B** under the core, and up between the core and **A** on the left (see figure 1, 2, 3). Pull tight.

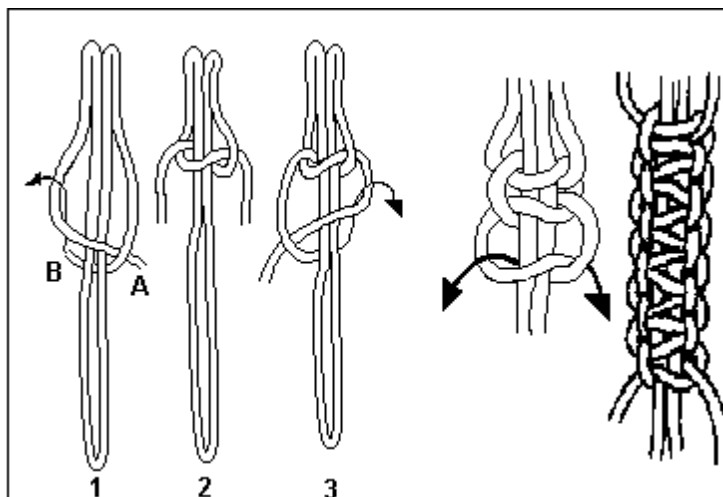

A and **B** have changed sides, thus the action is now reversed. **A** is laid across the core from right to left and under **B**. **B** goes under the core from left to right and up between the core and **A**. Pull tight every time and the result will look like figure 3, which is purposely drawn loose to show the pattern. It should be pulled as tight as possible in the actual working. It is obvious which end is **A** and which is **B**, because **A** emerges downwards, whereas **B** comes up through the loop.

A and **B** have changed sides, thus the action is now reversed. **A** is laid across the core from right to left and under **B**. **B** goes under the core from left to right and up between the core and **A**. Pull tight every time and the result will look like figure 3, which is purposely drawn loose to show the pattern. It should be pulled as tight as possible in the actual working. It is obvious which end is **A** and which is **B**, because **A** emerges downwards, whereas **B** comes up through the loop.

Rolling Boatswain:

This is a variation of the Boatswain's Weave. These may both be used effectively in the neck by working 70mm of each alternatively. The Rolling Boatswain is made in much the same way as the other, but instead of beginning by putting **A** across the core every time, first from the left then from the right, the **left-hand** end is laid across every time. Thus the weave is repeated as in Figure 1 and 2, the action never being reversed. This makes a variation in design and also causes the plait to twist or roll.

Alternate these two plaits till you have 7 sections, then make a short section 30mm long flat sennit, now start seven sections to match the last seven. When sufficient plait has been made to for the neck, untie the loose knot at the beginning, bringing the four short ends alongside the four long ones, and join all together with a Turks Head. There will now be eight ends with which to work.

Half Hitches:

A design in Half-Hitches may be introduced here. Begin two strands only, **A** and **B**. Hold **B** taught and tie a Half-Hitch on it with **A**, then hold **A** taught and make a Half-Hitch on it with **B**. If **B** is passed **over A** to make a Half-Hitch, then **A** must be passed over **B** in the same way.

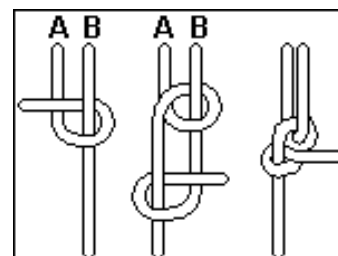

After working 7cm of this, put **A** and **B** aside and begin the same with another adjacent pair of strands. Continue until all the strands have been worked in pairs to a length of 7cm. Lay the strands together again ready to begin a new stitch.

Diamond Knot:

After the four sets of Half-Hitches should come a knot. A Diamond would look good, but will need much practice in string before it is attempted on a lanyard. Knot four lengths of string together, each about 9 inches long, and hold them between the first and second fingers of the left hand, end uppermost. Bring two ends forward and hold between the first finger and the thumb, leaving little loops standing above the first finger.

Carry the other two ends back and hold them between the second and third fingers, leaving loops as before. The forward loops should slant to the left, and the backwards loops to the right. Name the ends **A**, **B**, **C** and **D**, starting with the end on the front right.

Take **A** and carry it around behind the loop of **B** and put it through the loop of **C**. Carry **B** round **C** (underneath the end of **A**) and put it through the loop of **D**. Then **C** goes round **D** and through **A**. Finally, **D** goes round **A** and through **B**. Each time the working end must pass under the loose end of the previous strand. Now pull it tight and even.

When the knot has been thoroughly mastered, it can be tied on the lanyard, either using every two strands as one, or, if this is too confusing, with four outer strands round the inner ones left as a core. It is very handsome ties with all eight strands used as four.

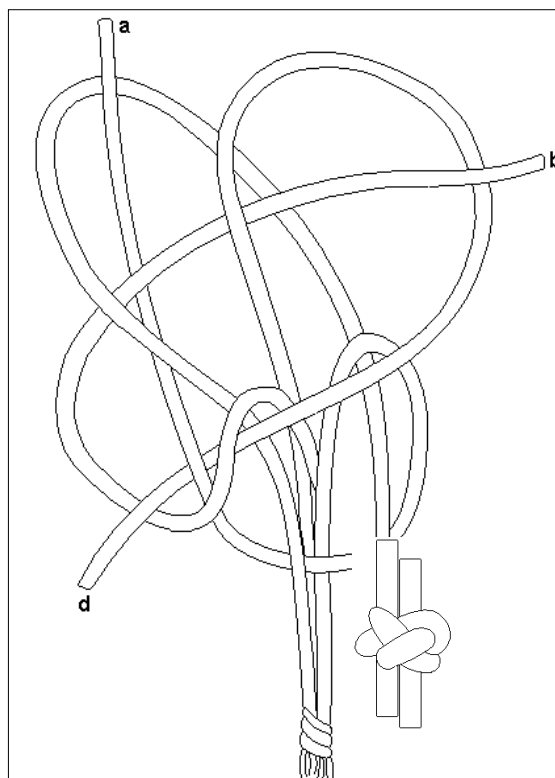

Crown Knots:

A good and easy plait to follow the Diamond, is one made of a series of Crown Knots made with double strands. A Crown Knot is used by sailors as a quick method of preventing a rope's end from unravelling. It should be practised first with a piece of stranded string or rope, or with three ends of string knotted together. Hold the strands between the left finger and thumb, end uppermost. Name the strands **A**, **B** and **C**. Lay **A** across **B**. Then lay **B** over the loose end of **A** and across **C**. Lastly, lay **C** over the loose end of **B** and pass it down through the loop formed by **A**. Pull tight.

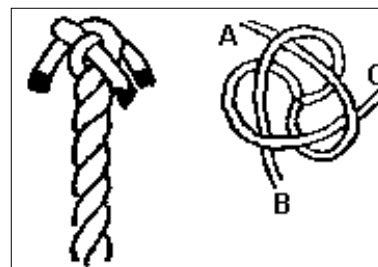

Next, try the crown with four lengths of string. It is made in exactly the same way as before, only now **C** will have to cross over **D** and **D** will go down the loop made by **A**. Each end must be pulled evenly to make a square knot.

To use the Crown Knot as a plait – after tying it once, reverse the action, laying **A** over **D**, **D** over **C**, **C** over **B** and **B** down the loop formed by **A**. Reverse in this way every time until quite proficient. Then work it on the lanyard where there are eight strands with which to work. Treat every pair of strands as one and begin tying the crowns. Each pair of ends must lie neatly side by side, never crossing. This takes a little arranging when pulling tight. It is easy to see which way the ends should be laid. If they lie clockwise next time and *vice versa*. The plait will then be seen to be a square. Continue the Double Square Crowning for 7cm. (If a round plait is to be made, the process should not be reversed each time, but done continuously in one direction – either clockwise or counter-clockwise).

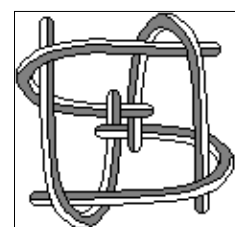
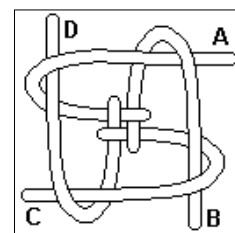

Grapevine:

Having done 7cm of the Crown Knots, the lanyard will need to decrease in bulk, as it will have to get quite slim in order to thread the ring of a knife. Simple Half-Hitches will cover this decrease. Gather seven of the strands together into a fat core, leaving the longest end to work with. Cut off two of the shortest strands of the core at different points within the next 7cm. Now make Half-Hitches round the core with the longest strand. The Half-Hitches must all be made by passing the strand under the core. This will cause the pattern to twist round the core from the left to the right, that is, in the same direction as the twist in the Rolling Boatswain. It spoils the symmetry of the lanyard if the twisting patterns do not all take the same direction. The Half-Hitches must lie close together and be pulled very tight. This seems a very simple hitch, but like all simple things, needs to be very well done.

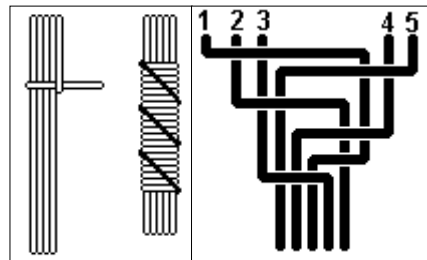

After 7cm of the Grapevine, change to the Three-Cornered Crowning.

Three-Cornered Crowning:

Having cut off two strands, there will be six left. Use three of these strands as a core and three outside ones as the working ends. During the working of the next 7cm, cut off one of the strands in the core. Naming the three outside strands **A**, **B** and **C** as before, make crown knots round the core by laying **A** over **B**. **B** over the loose end of **A** and across **C**, and **C** over the loose end of **D** and pass it down through the loop formed by **A**. Now reverse the process, laying **A** over **C**, **C** over **B** and **B** down through the loop formed by **A**. Reverse in this way every time. This will form a triangular-shaped knot, which is very effective, if pulled tightly and evenly.

Having done 7cm of this work, there will be five strands left and 28cm of lanyard will have been below the Turk's Head. If the lanyard is not long enough at this point, another Sennit should be included.

Flat Sennit:

This is a good hitch with which to end and makes a nice strong loop for a knife or call. Take the left outside strand (**1**) and pass it over the next two. Then, take the right outside strand (**5**) and pass it back over two. Continue plaiting ends alternately. This is just like an ordinary plait, only that you pass outside strands over two instead of over one end each time. Work about 200mm this way.

The end is now brought back to form a loop and the five strands firmly tied off. A Turk's Head is now made and slipped onto the lanyard to cover the fastening. Make a neat whipping for about 40mm up the lanyard; this will prevent the Turk's Head from coming loose with wear and tear.

Whipping:

This is made in the following way: Take a fresh length of plaiter's line and loop it alongside the lanyard in the opposite direction from the lanyard loop – leaving end **A** (about 50mm long) pointing to the right. Bind tightly with running end **B** over both lanyard and loop, starting at the Turk's Head and continuing to the left of 40mm until within 10mm of the loop end. Slip **B** through the loop that lays alongside the lanyard. Now cut off running end **B** about 50mm from the loop (and at the same time the running end **B**) into the binding. Trim the two ends **A** and **B** close to the completed whipping. Remember when making the turns to bind tightly.

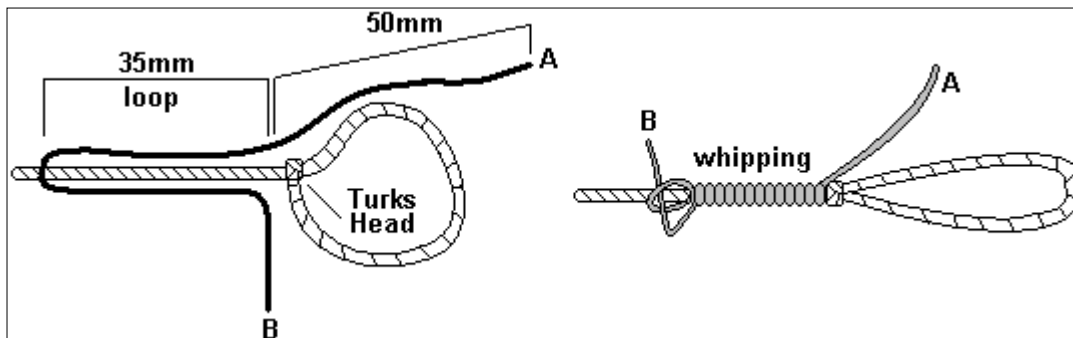

The following knots are pleasing and may be worked into subsequent lanyards, or as a substitute for some of the above.

Square Sennit:

This is a handsome plait and rather intriguing to make. It requires eight strands and when finished, is square, like its name and shows a plait on all four sides. Take the outside right hand strand, pass it under the next five and bring it back over two. You will soon find that you are making a Flat Sennit in the centre of your ends and care must be taken to keep it tight and even. Sometimes you may be confused as to which end to work with next; in that case, remember that the end to be used is the top one on the same side from which your last end passed over two. That is, if your last end, having been passed under from the left, goes over two from the right, the right hand top end is the next to be used.

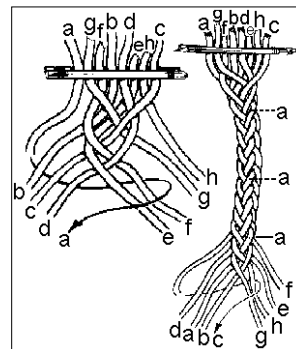
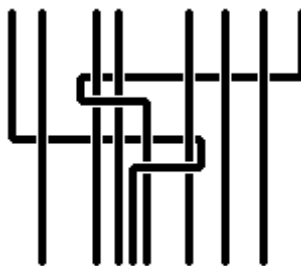

A very quickly worked and economical knot for making the neck loop of a lanyard is made as follows:

Take two pieces of plaiter's line - **X** and **Y** – knot the ends loosely together and slip over a chair back or something similar to hold the work steady and give something to pull against. Make a slip knot in cord **X**.



Now put a loop of cord **Y** through the loop of the slip knot in **X** and pull the end of **X** tight. Next, put the end of **X** through the loop of **Y** and pull **Y** tight. Continue this to put *the end you pull* through the loop last made by the other end. With a little practice, you will find that you can do this swiftly and evenly, and that you can make the neck of the lanyard in ten minutes or less. Also, very little cord is used, as only two ends are required. When you have done a sufficient length, pull one end completely through your last loop, this makes the chain fast, so that it cannot pull undone, then untie the knot at the beginning and tie your four ends together with a reef knot. Divide the rest of your line into four and double the ends over the reef knot, and proceed with Double Crowning or some other thick knotting. When the lanyard is finished, a Turk's Head may be put over the join.

A good stitch for the end of a lanyard is called **North, South, East and West**. Hold the lanyard, ends uppermost, between the first finger and thumb of the left hand, arranging the strands four square as the name suggests. Bring **North** down to the left of **South**, sending **South** up to take its place. Cross **West** and **East** in the same way, making **West** cross above **East**. Continue crossing the ends alternately, taking care that they always pass over one another on the same side, the strand coming from the **North** always passing that from the **South** on the left, and **West** always crossing above **East**.

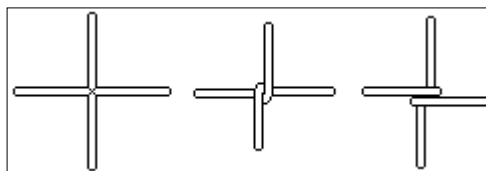

A very simple and fairly effective twist is easily made with eight or ten ends. Twist them two by two in pairs very tightly between the first finger and thumb. When all are tightly twisted, make them into a loose rope by winding all together in the opposite direction to that in which you twisted the pairs. Then tie a Half-Hitch tightly at the bottom to prevent unravelling. The twists will spring into place, but may need a little sorting to make them tie even.

Boatswains Chair

The Bosun's chair hitch, also known as the scaffold hitch, is made as shown in the sketches. Lay the short end of the rope over the plank, leaving enough hanging down to tie to the long rope finally. Now, wrap the long end loosely round the plank. Carry rope 1 over rope 2 and place it between rope 2 and 3. Carry rope 2 over ropes 1 and 3 and the end of the plank. Take up the slack by drawing on the two ends of the rope, and join the short end to the long rope at a convenient distance above the plank with a bowline. Repeat this procedure at the other end of the plank.

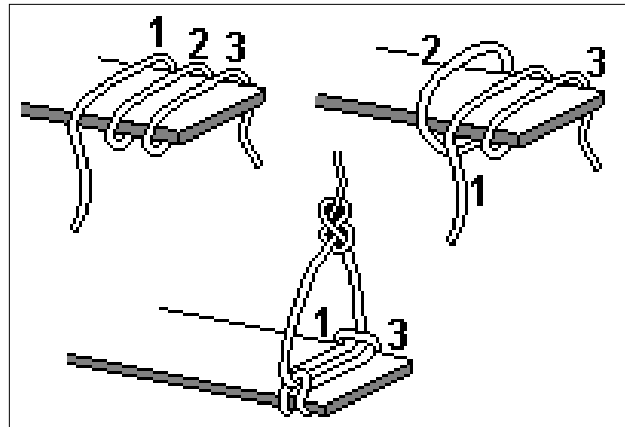

Purchase tackles

A tackle is a purchase consisting of a rope rove through two or more blocks in such a way that any pull applied to its hauling part is increased by an amount depending upon the number of sheaves in the blocks and the manner in which the rope is rove through them.

A block is a set of sheaves mounted on a single frame. A tackle is a system of ropes threaded through blocks, used to increase the force applied to the free end of the rope.

Rove to advantage – The pull on the rope is in the same direction as that in which the load is moving.

Rove to disadvantage – The pull on the rope is in the opposite direction to that in which the load is moving.

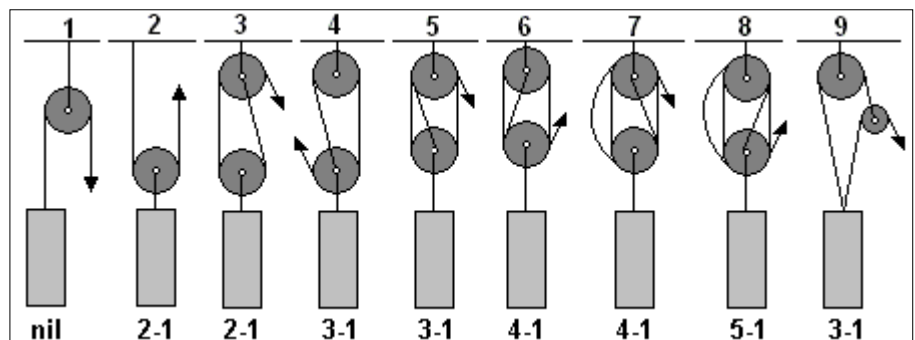
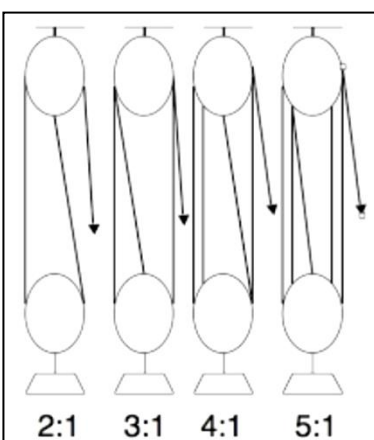

Sail maintenance

Keeping sails clean

“Terylene” sails should be washed in a liquid consisting of soap and soda or any proprietary brand of detergent, in water as hot as the hand can bear. At localised areas where soiling is particularly heavy, neat detergent can be applied and the treated sail left overnight before washing. If general soiling is persistent, the sails should be steeped in a solution made by dissolving 500g of **sodium metasilicate** to every 5 litres of water used. Avoid the use of vessels made of aluminium or galvanised iron. After this treatment, the sail should be hand washed and scrubbed lightly.

Removal of stains

The suggestions below refer **only to white material**. Coloured sails which become abnormally stained, should be dealt with by an experienced finisher or dry cleaner, especially when solvents or bleaching agents are involved in the stain removal technique.

Blood

Soak the stained portion in cold water containing half a cup full of ammonia to 2 ½ litres of water. If residual stains are present, damp the stain with a one percent solution of **pepsin** in water acidified with a few drops of **hydrochloric acid**. Allow to stand for 30 minutes and rinse thoroughly.

Mildew

Scrub *lightly* with a dry stiff brush, to remove as much of the mould as possible, then steep the stained portion for two hours in a cold solution consisting of one part **Domestos** to 10 parts water. Wash thoroughly in water, then steep in a solution containing one part of **sodium bisulphite** to every thousand parts of water. Rinse finally with water. Repeat the treatment if necessary.

Grease, Oil and Waxes

Small stains of this nature can be removed by dabbing with **trichlorethylene**, or by the use of proprietary stain removers such as **Coliclean**. Heavy staining is best removed by brushing on a mixture of detergent in a solvent. This can be prepared by dissolving one part of **Lissapol NX** in two parts of **benzine** or **toluol**, or alternatively, by brushing on a proprietary brand, such as **Policlens**. These solvent detergent mixtures should be brushed well into the fabric, left for about 15 minutes, then washed in warm water. A well ventilated place should be selected for applying this treatment and precautions should be exercised if the solvents are inflammable.

These treatments will remove oils, greases, Vaseline, lanolin and most lubricating mixtures, but they will not remove stains caused by fine metallic particles often associated with lubricants. These can be removed by the methods described below after all the oil or grease has been dealt with.

Metallic Stains

Stains caused by metals, in the form of rust, verdigris or finely divided particles can be removed by either or both the following methods:

- (a) Immerse the stained portion in a solution of five percent **oxalic acid** dissolved in hot water. The hands and fabrics should be well washed after using **oxalic acid** solution, as the chemical is poisonous.
- (b) Immerse the stained portion in a hot solution containing two percent **hydrochloric acid** in water. Rinse well after treatment.

Pitch and Tar

Solvent **Naphtha**, **white spirit**, **Westropol** or **trichlorethylene** may be dabbed onto the stain to effect removal.

Paint

Dab the stain first with **trichlorethylene** and then with a mixture of equal parts of **acetone** and **amyl acetate**. Paint strippers based on alkalis should **NOT** be used. Wash well afterwards.

Varnish

This can be removed in the same manner as for paint. Shellac varnish is easily removed with **alcohol** or **methylated spirits**.

Linseed Oil

Oxidised linseed oil is extremely difficult to remove, and the most successful treatment is rather severe, so great care should be exercised when carrying out the following suggestions. The stained portions should be treated with a *non-caustic paint stripper* such as **Nitromers** for a period of 15 minutes, then wash in soapy water. Next, immerse in a 5% solution of **caustic soda** (cold) for two hours and wash vigorously by hand in hot, soapy water, followed by a thorough rinsing. Ensure that the caustic soda is completely dissolved before use, since the action of caustic soda is detrimental to **Terylene**.

Lissapol and *Westropol* are trademarks, the proprietary of Imperial Chemical Industries Limited.

Domestos is a trademark, the property of Domestos Ltd.

Policlens is a trademark, the property of Polycell Product Ltd.

Coliclean is made by Coliclean Ltd. Of London.

Nitromers is made by Wilcot (Parent) Ltd., Fishponds, Bristol.

Stitching

Mending a Sail:

To patch a sail, replace the damaged or worn part with another piece of similar canvas that is *not new*. Sails must not be repaired with canvas equal to the original strength of the canvas with which they are made. Sometimes, a special canvas, termed repairing canvas, is available, but it is always safer to use old canvas.

The stitching of the repairing piece must be carefully done, so that the patch does not have either more or less weight on it than the surrounding sail. If the damage is simply a tear, it can be repaired with a "Sail makers Darn". This is done as follows:

Start the end nearest your left hand. Knot the twine and bring the needle up through the canvas on the side nearest to you. Put the needle down on the side furthest from you and bring it up through the slit on the left of your last stitch. Come over the last stitch and repeat to the end of the slit. If the canvas is weak at that point, the darn should be covered with a patch.

Sewing Canvas:

The tools required are a **seaming palm**, **seaming needle** (12½ or 15), a **sail hook** for holding the canvas, a **piece of beeswax**, **seaming twine**, **knife**, **rubber** (which is a smooth rounded piece of steel mounted on a wooden handle).

A fixed rule in sewing is that you work the needle so that its point moves away from you while stitching. The two seams used are the round seam and the flat seam. The round seam is made by turning in the selvage of one piece of canvas, laying the selvage of the other piece along the turned over part, putting the right hand ends of the two pieces on the sail hook, getting the canvas straight out, and sewing the single part to the double part with three overhand stitches to the inch or a little less than a stitch to a centimetre and working from left to right.

When finished, put the two canvasses with the oversewn seam down on a hard surface, open out the doubled part of the turned-in selvage and rub the seam flat with the rubber, going in the direction opposite to that of the stitching; i.e. rub down from the hook, sew towards the hook.

The flat or middle seam is made by overlaying the two edges for the required distance, putting the hook in the right-hand end, sewing from right to left with the canvas across the knees and putting the stitches about every 13mm. This is ordinary hemming, but with the point of the needle going away from the sewer. As usual, rub down in the direction opposite to the stitching.

The Bosun's Call and Pipes

Piping is a naval method of passing orders. Orders made in this manner are known as **Pipes**.

The use of the boatswain's call in English ships can be traced back with certainty to the days of the Crusades, AD 1248. In former days it was worn in English ships and fleets as an honoured badge of rank, probably because it had always been used for passing orders. As long ago as 1485 it was worn as the badge of office of the Lord High Admiral of England and was worn by his successors in office up to 1562. Thereafter it was used throughout the English fleets for passing all orders, and since about 1671 it has always been known as the boatswain's call.

Nowadays the boatswain's call and chain are the badge of office of the Chief Boatswain's Mate, quartermasters and boatswain's mates.

The Boatswain's Call is held between the index finger and the thumb, with the thumb being on or near the shackle. The side of the buoy rests against the palm of the hand, the fingers close over the gun and buoy hole, so as to throttle the exit of air from the buoy to the required amount. Keep the fingers away from both the hole of the buoy and the hole of the gun. If you don't, you will choke all sound. By opening and closing the fingers, you can create a variety of sounds; the amount of air blown through the gun can also affect the notes.

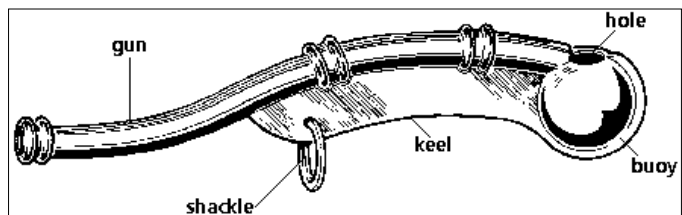

You have three notes: **High, Middle, Low**, and in piping you use three tones: **Plain, Warble, Trill**.

To obtain the notes and tones, proceed as follows:

- High** By throttling the outlet of air by closing the fingers round the buoy.
- Middle** By opening the fingers slightly.
- Low** Blowing steadily with the fingers straight and well clear of the hole.
- Plain** The steady blowing produces a plain note, this is indicated by a straight line.
- Warble** This is obtained by opening and closing the hand while blowing steadily.
- Trill** The vibrating of the tongue while blowing steadily as in rolling the letter "R", in the diagram, this is shown by short and sharp zigzags.

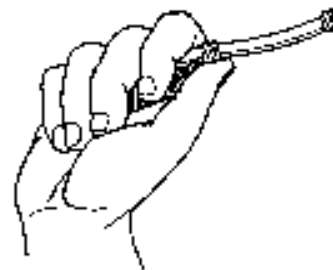
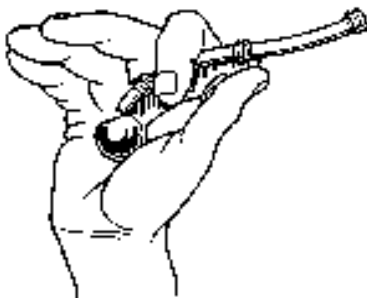

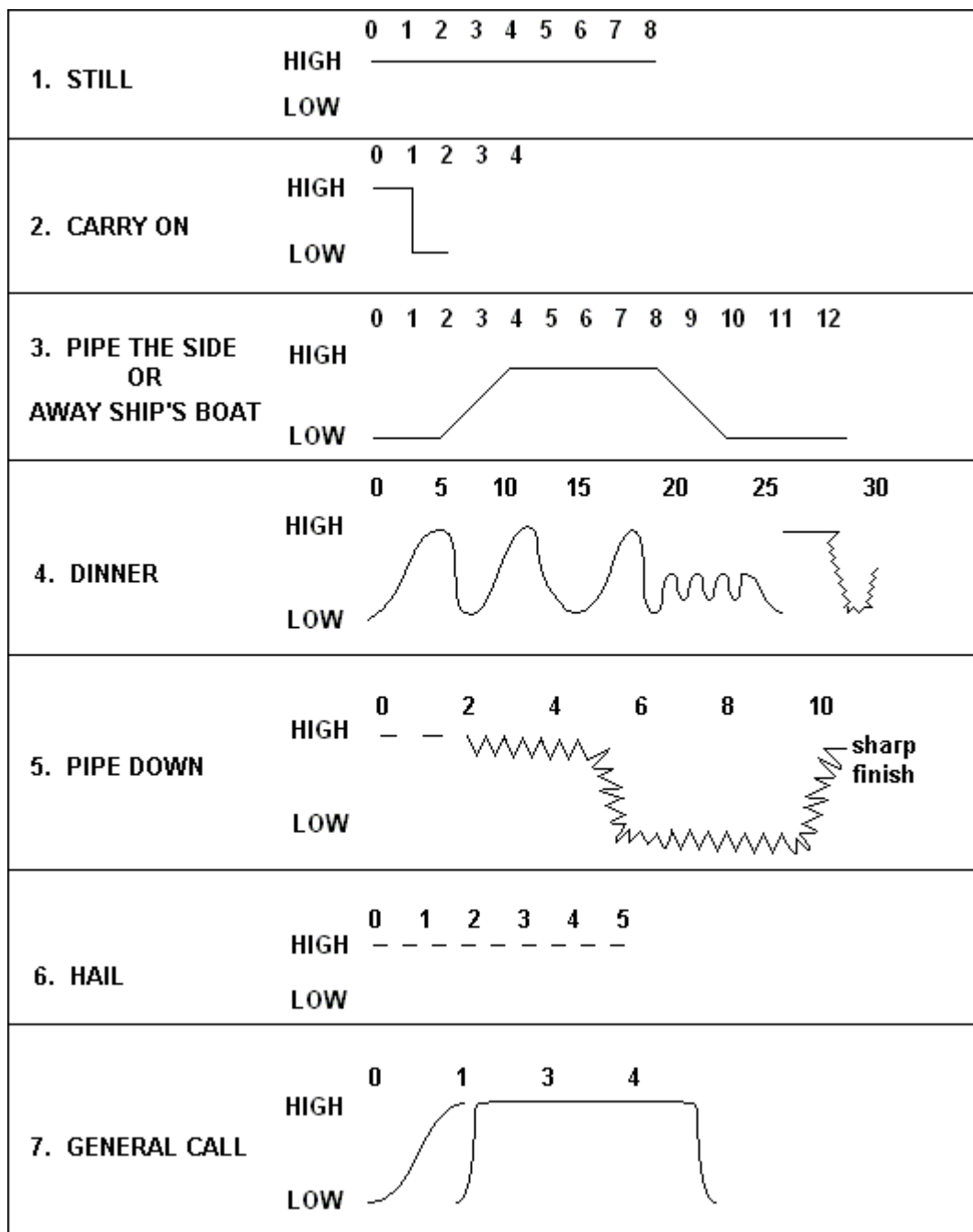

Contents of a Boat Bag

Number	Description of Contents
1	NEEDLE
2	PALM
3	COBBLERS WAX
4	BALL OF TWINE
5	HANK OF THREAD
6	SWIVEL SAIL HOOK ON LANYARD
7	SHARP KNIFE
8	CANVAS
9	MARLIN SPIKE
10	WOODEN FID
11	HAMMER
12	SCREWDRIVER
13	PLIERS
14	SAW
15	WOOD CHISEL
16	BRADAWL
17	SPARE SHACKLES
18	SMALL TIN OF GREASE
19	SPARE BUNGS
20	SAND PAPER
21	OLD CLOTH
22	1m ² CHOPPED STRAND MAT
23	G.P. RESIN
24	M.E.K.P. HARDENER
25	CAKE OF SUNLIGHT SOAP
26	MIXING TIN
27	ASSORTED BRASS SCREWS
28	PAINT BRUSH
29	WATER PROOF TAPE
30	CORKS (wine bottles)